



**Cat 5 High-Density KVM Switch
KH1508 / KH1516
User Manual**



FCC Information

This is an FCC Class A product. In a domestic environment this product may cause radio interference in which case the user may be required to take adequate measures.

This equipment has been tested and found to comply with the limits for a Class A digital device, pursuant to Part 15 of the FCC Rules. These limits are designed to provide reasonable protection against harmful interference when the equipment is operated in a commercial environment. This equipment generates, uses and can radiate radio frequency energy and, if not installed and used in accordance with the instruction manual, may cause harmful interference to radio communications. Operation of this equipment in a residential area is likely to cause harmful interference in which case the user will be required to correct the interference at his own expense.

RoHS

This product is RoHS compliant.



User Notice

All information, documentation, and specifications contained in this manual are subject to change without prior notification by the manufacturer. The manufacturer makes no representations or warranties, either expressed or implied, with respect to the contents hereof and specifically disclaims any warranties as to merchantability or fitness for any particular purpose. Any of the manufacturer's software described in this manual is sold or licensed 'as is'. Should the programs prove defective following their purchase, the buyer (and not the manufacturer, its distributor, or its dealer), assumes the entire cost of all necessary servicing, repair and any incidental or consequential damages resulting from any defect in the software.

The manufacturer of this system is not responsible for any radio and/or TV interference caused by unauthorized modifications to this device. It is the responsibility of the user to correct such interference.

The manufacturer is not responsible for any damage incurred in the operation of this system if the correct operational voltage setting was not selected prior to operation. **PLEASE VERIFY THAT THE VOLTAGE SETTING IS CORRECT BEFORE USE.**

Safety Instructions

General

- ◆ Read all of these instructions. Save them for future reference.
- ◆ Follow all warnings and instructions marked on the device.
- ◆ Do not place the device on any unstable surface (cart, stand, table, etc.). If the device falls, serious damage will result.
- ◆ Do not use the device near water.
- ◆ Do not place the device near, or over, radiators or heat registers.
- ◆ The device cabinet is provided with slots and openings to allow for adequate ventilation. To ensure reliable operation, and to protect against overheating, these openings must never be blocked or covered.
- ◆ The device should never be placed on a soft surface (bed, sofa, rug, etc.) as this will block its ventilation openings. Likewise, the device should not be placed in a built in enclosure unless adequate ventilation has been provided.
- ◆ Never spill liquid of any kind on the device.
- ◆ Unplug the device from the wall outlet before cleaning. Do not use liquid or aerosol cleaners. Use a damp cloth for cleaning.
- ◆ The device should be operated from the type of power source indicated on the marking label. If you are not sure of the type of power available, consult your dealer or local power company.
- ◆ The device is equipped with a 3-wire grounding type plug. This is a safety feature. If you are unable to insert the plug into the outlet, contact your electrician to replace your obsolete outlet. Do not attempt to defeat the purpose of the grounding-type plug. Always follow your local/national wiring codes.
- ◆ Do not allow anything to rest on the power cord or cables. Route the power cord and cables so that they cannot be stepped on or tripped over.
- ◆ If an extension cord is used with this device make sure that the total of the ampere ratings of all products used on this cord does not exceed the extension cord ampere rating. Make sure that the total of all products plugged into the wall outlet does not exceed 15 amperes.
- ◆ To help protect your system from sudden, transient increases and decreases in electrical power, use a surge suppressor, line conditioner, or uninterruptible power supply (UPS).

- ◆ Position system cables and power cables carefully; Be sure that nothing rests on any cables.
- ◆ When connecting or disconnecting power to hot pluggable power supplies, observe the following guidelines:
- ◆ Install the power supply before connecting the power cable to the power supply.
- ◆ Unplug the power cable before removing the power supply.
- ◆ If the system has multiple sources of power, disconnect power from the system by unplugging all power cables from the power supplies.
- ◆ Never push objects of any kind into or through cabinet slots. They may touch dangerous voltage points or short out parts resulting in a risk of fire or electrical shock.
- ◆ Do not attempt to service the device yourself. Refer all servicing to qualified service personnel.
- ◆ If the following conditions occur, unplug the device from the wall outlet and bring it to qualified service personnel for repair.
 - ◆ The power cord or plug has become damaged or frayed.
 - ◆ Liquid has been spilled into the device.
 - ◆ The device has been exposed to rain or water.
 - ◆ The device has been dropped, or the cabinet has been damaged.
 - ◆ The device exhibits a distinct change in performance, indicating a need for service.
 - ◆ The device does not operate normally when the operating instructions are followed.
- ◆ Only adjust those controls that are covered in the operating instructions. Improper adjustment of other controls may result in damage that will require extensive work by a qualified technician to repair.

Rack Mounting

- ◆ Before working on the rack, make sure that the stabilizers are secured to the rack, extended to the floor, and that the full weight of the rack rests on the floor. Install front and side stabilizers on a single rack or front stabilizers for joined multiple racks before working on the rack.
- ◆ Always load the rack from the bottom up, and load the heaviest item in the rack first.
- ◆ Make sure that the rack is level and stable before extending a device from the rack.
- ◆ Use caution when pressing the device rail release latches and sliding a device into or out of a rack; the slide rails can pinch your fingers.
- ◆ After a device is inserted into the rack, carefully extend the rail into a locking position, and then slide the device into the rack.
- ◆ Do not overload the AC supply branch circuit that provides power to the rack. The total rack load should not exceed 80 percent of the branch circuit rating.
- ◆ Ensure that proper airflow is provided to devices in the rack.
- ◆ Do not step on or stand on any device when servicing other devices in a rack.

Package Contents

The KH1508 / KH1516 package consists of:

- 1 KH1508 or KH1516 Cat 5 High-Density KVM Switch
- 1 Firmware Upgrade Cable
- 1 Power Cord
- 1 Rack Mount Kit
- 1 Foot Pad Set (4 pcs.)
- 1 User Manual*
- 1 Quick Start Guide
- 1 Registration Card

Check to make sure that all of the components are present and in good order. If anything is missing, or was damaged in shipping, contact your dealer.

Read this manual thoroughly and follow the installation and operation procedures carefully to prevent any damage to the switch or to any other devices on the KH1508 / KH1516 installation.

* Features may have been added to the KH1508 / KH1516 since this manual was printed. Please visit our website to download the most up-to-date version of the manual.

Copyright © 2006 ATEN® International Co., Ltd.
Manual Part No. PAPE-0268-1AXG
Printing Date: 10/2006

Altusen and the Altusen logo are registered trademarks of ATEN International Co., Ltd. All rights reserved.
All other brand names and trademarks are the registered property of their respective owners.

Contents

FCC Information	ii
RoHS	ii
User Notice	iii
Safety Instructions	iv
General	iv
Rack Mounting	vi
Package Contents	vii
About This Manual	xi
Overview	xi
Conventions	xii
ALTUSEN Information	xiii
Technical Support	xiii
Getting Help	xiii
Product Information	xiv

Chapter 1.

Introduction

Overview	1
Features	3
Requirements	4
Console	4
Computers	4
KVM Adapter Cables (CPU Modules)	4
Operating Systems	5
Components	6
Front View	6
KH1508	6
KH1516	6
Rear View	8
KH1508	8
KH1516	8

Chapter 2.

Hardware Setup

Overview	9
Before You Begin	9
Stacking and Rack Mounting	10
Stacking	10
Rack Mounting	11
Single Station Installation	12
Single Stage Installation Diagram	13
KVM Adapter Cable Installation Diagrams	14
Daisy Chaining	15
Daisy Chain Installation Diagram	16

Chapter 3.**Basic Operation**

Port Selection	17
Manual	17
OSD	17
Hotkey	17
Hot Plugging	18
Hot Plugging Stations	18
Hot Plugging KVM Ports	18
Hot Plugging Console Ports:	18
Powering Off and Restarting	19
Port ID Numbering	19

Chapter 4.**OSD Operation**

Overview	21
OSD Navigation	23
OSD Main Screen Headings	23
OSD Functions	24
F1 GOTO	24
F2 LIST	25
F3 SET	26
F4 ADM	28
F5 SKP	32
F7 SCAN	33
F8 LOUT	34

Chapter 5.**Hotkey Operation**

Hotkey Port Control	35
Invoking Hotkey Mode	35
Selecting the Active Port	36
Auto Scanning	36
Setting the Scan Interval	36
Invoking Auto Scan	37
Skip Mode	38
Hotkey Beeper Control	39
Hotkey Summary Table	39

Chapter 6.**Keyboard Emulation**

Mac Keyboard	41
Sun Keyboard	42

Chapter 7.

Firmware Upgrade

KH1508 / KH1516 Upgrade	43
Introduction	43
Before You Begin	43
Performing the Upgrade	44
Starting the Upgrade:	44
Upgrade Succeeded:	47
Upgrade Failed:	47
Firmware Upgrade Recovery	48
Adapter Cable Upgrade	49
Introduction	49
Before You Begin	49
Performing the Upgrade	50
Starting the Upgrade:	50
Upgrade Succeeded:	51
Firmware Upgrade Recovery	52

Appendix

Connection Tables	53
KH1508	53
KH1516	53
OSD Factory Default Settings	54
Specifications	55
Administrator Login Failure	56
Troubleshooting	57
Limited Warranty	57

Index

About This Manual

This User Manual is provided to help you get the most from your KH1508 / KH1516 system. It covers all aspects of installation, configuration and operation. An overview of the information found in the manual is provided below.

Overview

Chapter 1, Introduction, introduces you to the KH1508 / KH1516 system. Its purpose, features and benefits are presented, and its front and back panel components are described.

Chapter 2, Hardware Setup, describes how to set up your installation. The necessary steps – from a basic single stage hookup to a complete 32 switch daisy chained operation are provided.

Chapter 3, Basic Operation, explains the fundamental concepts involved in operating the KH1508 / KH1516.

Chapter 4, OSD Operation, provides a complete description of the KH1508 / KH1516's OSD (On Screen Display), and how to work with it.

Chapter 5, Hotkey Operation, details all of the concepts and procedures involved in the Hotkey operation of your KH1508 / KH1516 installation.

Chapter 6, Keyboard Emulation, provides tables that list the PC to Mac and PC to Sun keyboard emulation mappings.

Chapter 7, Firmware Upgrade, explains how to upgrade the KH1508 / KH1516's firmware with the latest available versions.

An Appendix, provides specifications and other technical information regarding the KH1508 / KH1516.

Conventions

This manual uses the following conventions:

- | | |
|---|--|
| Monospaced | Indicates text that you should key in. |
| [] | Indicates keys you should press. For example, [Enter] means to press the Enter key. If keys need to be chorded, they appear together in the same bracket with a plus sign between them: [Ctrl+Alt]. |
| 1. | Numbered lists represent procedures with sequential steps. |
| ◆ | Bullet lists provide information, but do not involve sequential steps. |
| → | Indicates selecting the option (on a menu or dialog box, for example), that comes next. For example, Start → Run means to open the <i>Start</i> menu, and then select <i>Run</i> . |
|  | Indicates critical information. |

ALTUSEN Information

Technical Support

North America Technical Phone Support	Registered ALTUSEN product owners are entitled to telephone technical support. Call the ALTUSEN Technical Support Center: 949-453-8885.
International Technical Phone Support	<ol style="list-style-type: none"> 1. Contact your local dealer. 2. Call the ALTUSEN Technical Support Center:(886-2) 8692-6959.
Email Support	Email your questions and concerns to: support@aten.com
Online Support <ul style="list-style-type: none"> ◆ Troubleshooting ◆ Documentation ◆ Software Updates 	Online troubleshooting that describes the most commonly encountered problems and offers possible solutions to them; online documentation (including electronically available manuals); and the latest drivers and firmware for your product are available at the ALTUSEN website: http://www.aten.com

Getting Help

For additional help, advice, and information, ALTUSEN provides several support options. If you need to contact ALTUSEN technical support with a problem, please have the following information ready beforehand:

- ◆ Product model number, serial number, and date of purchase.
- ◆ Your computer configuration, including operating system, revision level, expansion cards, and software.
- ◆ Any error messages displayed at the time the error occurred.
- ◆ The sequence of operations that led up to the error.
- ◆ Any other information you feel may be of help

Product Information

For information about all of ALTUSEN's products and how they can help you connect without limits, visit ALTUSEN on the web or contact an ALTUSEN Authorized Reseller.

- ◆ In the United States of America, call: 866-ALTUSEN (258-8736)
- ◆ In Canada and South America, call: 949-453-8885
- ◆ In all other locations, call: 886-2-8692-6789
- ◆ Visit ALTUSEN on the web at <http://www.aten.com> for a list of locations and telephone numbers

Chapter 1

Introduction

Overview

The KH1508 / KH1516 KVM Switches are control units that allow access to multiple computers from a single KVM (keyboard, monitor, and mouse) console.

A single KH1508 / KH1516 can control up to 8 / 16 computers. As many as 31 additional KH1508 / KH1516 switches can be daisy chained from the original unit, so that up to 512 computers can all be controlled from the original KVM console.

Note: Aten ACS1208 / ACS1216 switches can also be installed on a KH1508 / KH1516 daisy chain.

A custom ASIC (patent pending) provides an auto-sensing function that recognizes the position of each station on the chain, eliminating the need to manually set the position with DIP switches. A seven segment front panel LED displays each Station's position for easy identification.

The switches feature RJ-45 connectors and CAT 5 cable to link to the computers. Combined with Auto Signal Compensation (ASC), 1280 x 1024 @ 60Hz signals can travel up to 40 m (130') – eliminating the need for KVM extenders. Utilizing PS/2 and USB KVM Adapter Cables for the final linkup, the KH1508 / KH1516 permits any combination of PCs, Macs, Sun computers, and serial devices to coexist on the installation.

Your KH1508 / KH1516 investment is protected by a Firmware Upgrade Utility. You can stay current with the latest improvements in functionality by downloading firmware update files from our website, and using the utility to quickly and conveniently install them.

Setting up the KH1508 / KH1516 is fast and easy; plugging cables into their appropriate ports is all that is entailed. Because the KH1508 / KH1516 intercepts keyboard and mouse input directly, there is no software to configure; no need to get involved in complex installation routines; no need to be concerned with incompatibility problems.

Access to any computer on the installation is easily accomplished--either by pressing front panel port selection switches; entering hotkey combinations from the keyboard; or by means of a powerful menu driven OSD (On Screen Display) system. A convenient Auto Scan function also permits automatic scanning and one-by-one monitoring of the activities of selected computers.

There is no better way to save time and money than with a KH1508 / KH1516 installation. By allowing a single console to manage up to 512 computers, a KH1508 / KH1516 installation: (1) eliminates the expense of having to purchase a separate keyboard, monitor, and mouse for each; (2) saves all the space those extra components would take up; (3) saves on energy costs; and (4) eliminates the inconvenience and wasted effort involved in constantly moving from one computer to another.

Features

- ◆ A single console controls up to 8 (KH1508) or 16 (KH1516) computers
- ◆ Dedicated chain ports - daisy chain up to 31 additional units - control up to 512 computers from a single console
- ◆ Extends the distance between computers and switch - up to 30m (100') for resolutions of 1600 x 1200 @ 60Hz; up to 40 m (130') for resolutions of 1280 x 1024 @ 60Hz
- ◆ Custom ASIC (patent pending) auto-senses station's position on daisy chained installations - no need for manual DIP switch setting - front panel LED indicates station's position
- ◆ Multiplatform support: PC, Mac, Sun and terminal-based systems
- ◆ No software required - convenient computer selection via port selection switches, *Hotkeys* and intuitive On Screen Display (OSD) menus
- ◆ Auto Scan feature for monitoring user-selected computers
- ◆ Hot Pluggable - add or remove switches/computers without having to power down the switches
- ◆ Two level password security - only authorized users view and control the computers - up to four Users plus an Administrator with separate profiles for each
- ◆ Two level logout - Manual and Timed
- ◆ PS/2 keyboard and mouse emulation - computers boot even when the console focus is elsewhere
- ◆ Superior video quality - supports resolutions up to 1600 x 1200 @ 60 Hz; DDC2B
- ◆ Multi-language keyboard support: American/UK English; French; German; Traditional Chinese; Japanese; Korean
- ◆ Rack Mountable in 19" System Rack (1U)

Requirements

Console

- ◆ A VGA, SVGA, or Multisync monitor capable of the highest resolution that you will be using on any computer in the installation.
- ◆ A PS/2 style mouse
- ◆ A PS/2 style keyboard

Computers

The following equipment must be installed on the computers that connect to the KH1508 or KH1516's KVM ports:

- ◆ A VGA, SVGA or Multisync port
- ◆ A Type A USB port and USB host controller (for USB KVM Adapter Cable Connection, see below)
- ◆ 6-pin mini-DIN keyboard and mouse ports (for PS/2 KVM Adapter Cable Connection, see below)

KVM Adapter Cables (CPU Modules)

- ◆ Cat 5 (or higher) cable is required to connect the KH1508 / KH1516 to one of the KVM Adapter Cables (see *Single Station Installation*, page 12).
- ◆ The following KVM Adapter Cables are required for use with the KH1508 / KH1516:

Function	Module
Connect to devices with PS/2 ports	KA9520
Connect to devices with USB ports	KA9570
Connect to Sun Legacy systems (with 13W3 port)	KA9130
Connect to Sun USB systems	KA9131
Connect to serial based devices	KA9140

Operating Systems

- ♦ DOS: 6.2 and higher
- ♦ Windows: Win 95 and higher
- ♦ Linux:
 - ♦ Red Hat 6.0 and higher
 - ♦ Mandrake/Mandriva 9.0 and higher
 - ♦ SUSE 8.2 and higher
- ♦ Free BSD 3,51 and higher
- ♦ Netware 5.0 and higher
- ♦ OS/2
- ♦ AIX 4.3 and higher
- ♦ Sun Solaris 8 and higher

Components

Front View

KH1508

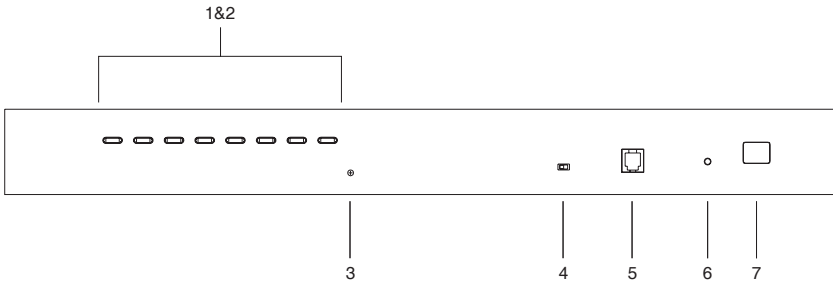

KH1516

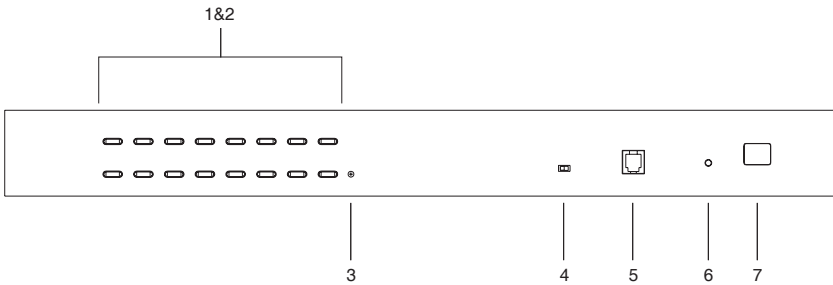

No.	Component	Description
1	Port Selection Switches	<ul style="list-style-type: none"> ◆ Press a switch to give the KVM focus to the computer attached to its corresponding port. ◆ Simultaneously pressing Buttons 1 and 2 for 3 seconds performs a Keyboard and Mouse Reset. ◆ Simultaneously pressing Buttons 7 and 8 starts Auto Scan Mode.
2	Port LEDs	<p>The Port LEDs are built into the Port Selection Switches. The upper ones are the <i>On Line</i> LEDs; the lower ones are the <i>Selected Port</i> LEDs:</p> <ul style="list-style-type: none"> ◆ An On Line LED lights GREEN to indicate that the computer attached to its corresponding port is up and running. A flashing LED indicates that the Port is being used for cascading to another switch. ◆ A Selected LED lights ORANGE to indicate that the computer attached to its corresponding port is the one that has the KVM focus. The LED is steady under normal conditions, but flashes when its port is accessed under Auto Scan Mode.
3	Reset Switch	<p>Pressing this switch in performs a system reset.</p> <p>Note: The switch is recessed and must be pushed with a thin object - such as the end of a paper clip, or a ballpoint pen.</p>
4	Firmware Upgrade Recovery Switch	<p>During normal operation and while performing a firmware upgrade, this switch should be in the NORMAL position. If a firmware upgrade operation does not complete successfully, this switch is used to perform a firmware upgrade recovery. See <i>Firmware Upgrade Recovery</i>, page 48 for details.</p>
5	Firmware Upgrade Port	<p>The Firmware Upgrade Cable that transfers the firmware upgrade data from the administrator's computer to the KH1508 / KH1516 (see page 43), plugs into this RJ-11 connector.</p>
6	Power LED	<p>Lights to indicate that the KH1508 / KH1516 is powered up and ready to operate.</p>
7	Station ID LED	<p>The KH1508 / KH1516's Station ID is displayed here. If this is a Single Station installation (see page 12), or the First Station on a Daisy Chained installation (see page 15), the KH1508 / KH1516 has a Station ID of 01.</p> <p>On a Daisy Chained installation, the KH1508 / KH1516 auto-senses its position and displays the Station ID that corresponds to its place in the chain. (see <i>Port ID Numbering</i>, page 19, for details).</p>

Rear View

KH1508

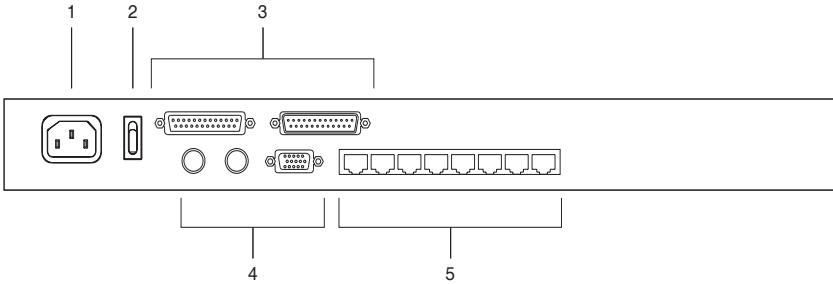

KH1516

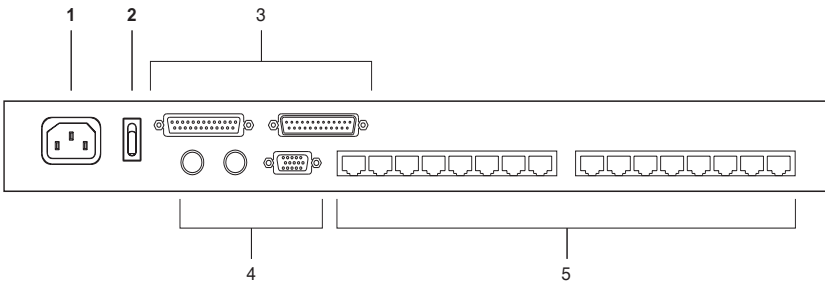

No.	Component	Description
1	Power Socket	
2	Power Switch	
3	Daisy Chain Ports	When Daisy Chaining Units (see <i>Daisy Chaining</i> , page 15), the daisy chain cables plug in here. The port on the left is the <i>Chain In</i> port; the port on the right is the <i>Chain Out</i> port.
4	Local Console Port Section	If this is a Single Station installation, or if this is the First Station of a daisy chained installation, the keyboard, monitor, and mouse that make up the Local Console plug in here.
5	KVM Port Section	The Cat 5 cables that link to the KVM Adapter Cables (which link to the computers) plug in here.

Chapter 2

Hardware Setup

Overview

For convenience and flexibility that allows mixing the PS/2, USB, and serial device interfaces, as well as multiple platforms, the KH1508 / KH1516's design utilizes KVM Adapter Cables (CPU Modules), that serve as intermediaries between the switch and the connected devices (refer to the installation diagram on page 13).

A separate KVM Adapter Cable is required for each computer or device connection. See *KVM Adapter Cables (CPU Modules)*, page 4 for the model numbers.

Before You Begin



1. Important safety information regarding the placement of this device is provided on page iv. Please review it before proceeding.
2. Make sure that power to all the devices you will be connecting up have been turned off. You must unplug the power cords of any computers that have the Keyboard Power On function.

Stacking and Rack Mounting

The KH1508 / KH1516 can be stacked on the desktop or rack mounted at the front or rear of the rack. The following sections take you through the procedures for each method.

Stacking

The KH1508 / KH1516 can be placed on any appropriate level surface that can safely support its weight plus the weight of its attached cables. To place the KH1508 / KH1516, or to stack units if you are daisy chaining them, remove the backing material from the bottom of the rubber feet that came with this package, and stick them onto the switch's bottom panel at the corners, as shown in the diagram, below:

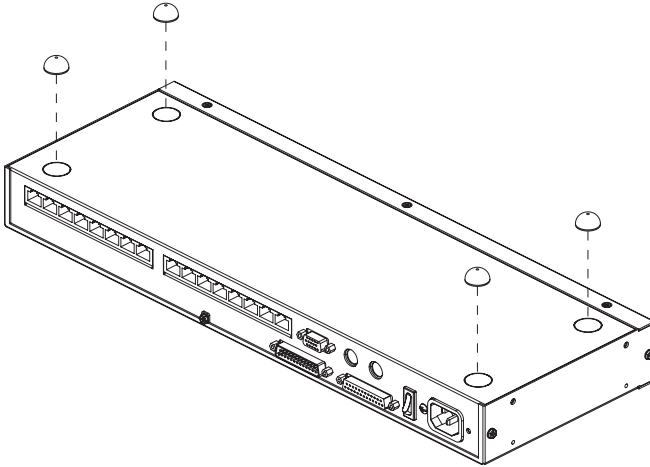

Note: To ensure adequate ventilation, allow at least 5.1 cm on each side, and 12.7cm at the back for power cord and cable clearance.

Rack Mounting

The KH1508 / KH1516 can be mounted in a 19" (1U) racks. The mounting brackets can screw into either the front or the back of the unit so that it can attach to the front or the back of the rack. To rack mount the unit:

1. Remove the screws at the front or the rear, as shown in the diagram below.

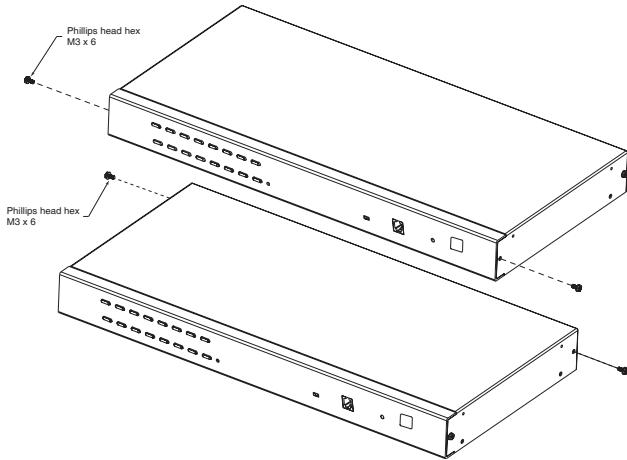

2. Screw the mounting brackets into the sides of the unit at the front or the rear, as shown in the diagram below.

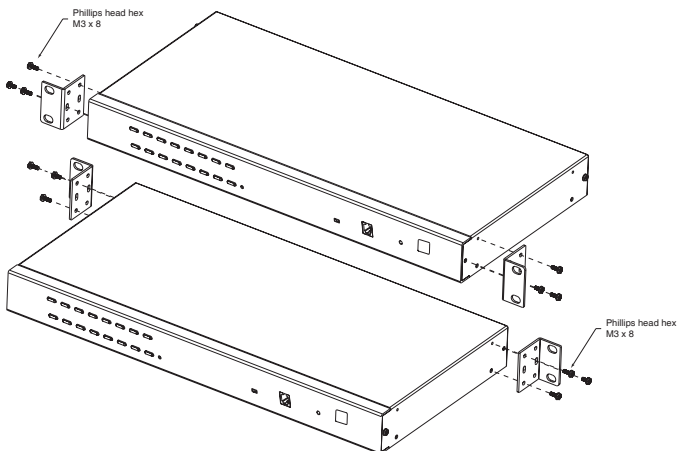

3. Slide the unit into the front or rear of the rack and secure it to the rack.

Single Station Installation

In a Single Stage installation, there are no additional KVM switches cascaded down from the KH1508 / KH1516. To set up a single stage installation, refer to the installation diagrams starting on page 13 (the numbers in the diagram correspond with the numbers of the instruction steps), and do the following:

1. Plug your Local Console's keyboard, monitor, and mouse into the unit's Console Ports. Each port is color coded and marked with an appropriate icon to identify itself.
2. Use Cat. 5 cable to connect any available KVM port to a KVM Adapter Cable that is appropriate for the computer you are installing (see *KVM Adapter Cables (CPU Modules)*, page 4 for details).

Note: The KH1508 / KH1516 does not support distances between itself and the KVM Adapter Cable that exceed 40 m.

3. Connect the KVM Adapter Cable to the computer.
Plug the connectors on the KVM Adapter Cable into the appropriate ports of the computer you are installing. (See *KVM Adapter Cable Installation Diagrams*, page 14 for connection examples.)
4. Plug the female end of the power cord into the KH1508 / KH1516's Power Socket; plug the male end into an AC power source.
5. Turn on the power to the KH1508 / KH1516.

After the KH1508 / KH1516 is powered up, you can turn on the computers.

Single Stage Installation Diagram

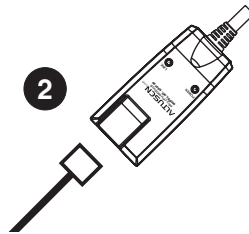
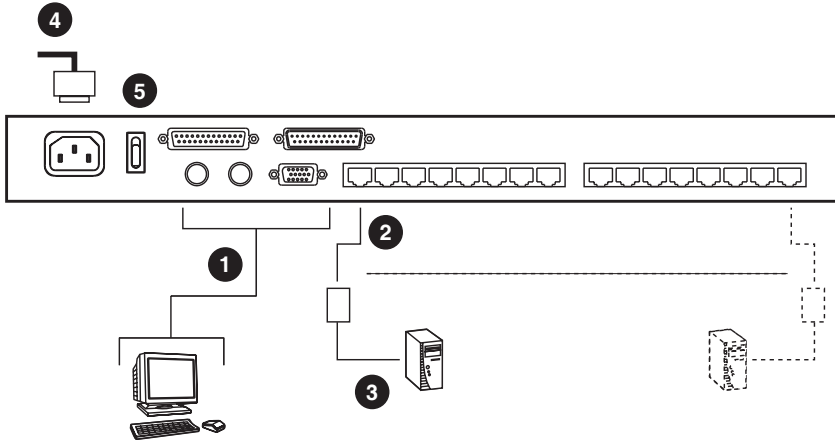

KVM Adapter Cable Installation Diagrams

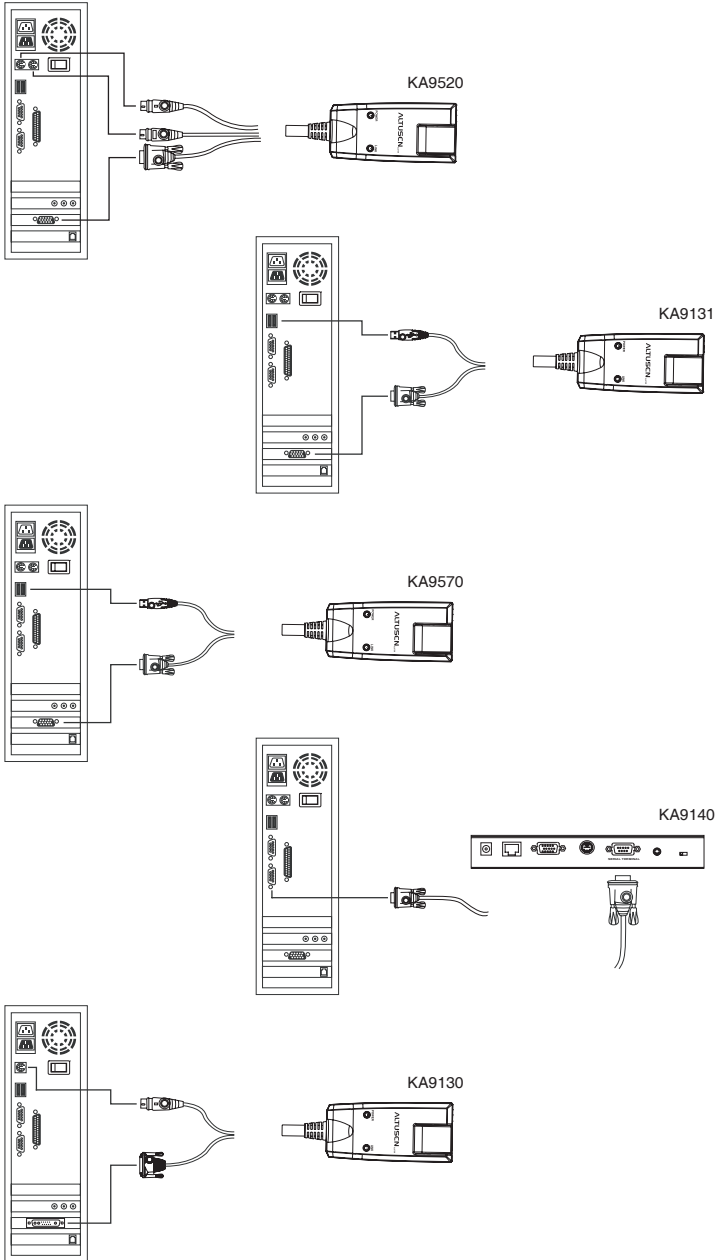

Daisy Chaining

To control even more computers, up to 31 additional KH1508 / KH1516 KVM switches can be cascaded from the KVM ports of the KH1508 or KH1516. As many as 512 computers can be controlled from a single console in a complete installation.

Note: Aten ACS1208 / ACS1216 switches can also be installed on a KH1508 / KH1516 daisy chain.

Tables showing the relation between the number of computers and the number of KH1508 / KH1516 units needed to control them is provided on page 53.

To set up a daisy chained installation, do the following:

1. Use a daisy chain cable set to connect the *Chain Out* port of the parent KH1508 / KH1516 unit to the *Chain In* port of the child KH1508 / KH1516 unit (First Station Out to Second Station In, Second Station Out to Third Station In, etc.).

Note: 1. You cannot use the Chain In port of the First Station, since it is the highest level parent.

2. Daisy chain cable sets require a separate purchase—see your dealer for details.
-

2. Use Cat. 5 cable to connect any available KVM port to a KVM Adapter Cable that is appropriate for the computer you are installing (see *KVM Adapter Cables (CPU Modules)*, page 4 for details).

Note: The KH1508 / KH1516 does not support distances between itself and the KVM Adapter Cable that exceed 40 m.

3. Connect the KVM Adapter Cable to the computer.
 4. Use the power cord supplied with this package to connect the KH1508 / KH1516 to an AC power source.
 5. Repeat steps 1–4 for any other switches you want to add to the chain.
 6. Power up the installation according to the following procedure:
 - a) Plug in the power adapter for the First Station. Wait for the unit to ascertain its Station ID and display it on the Station ID LED. (The Station ID for the First Stage unit is 01, the ID for the Second Stage unit is 02, the ID for the Third Stage unit is 03, etc.)
-

- b) Power on each station on the installation in turn (Second Station, then Third Station, etc.). In each case, wait for the Station ID to be ascertained and displayed before powering on the next station.
- c) After all the Stations are up, power on the computers.

Daisy Chain Installation Diagram

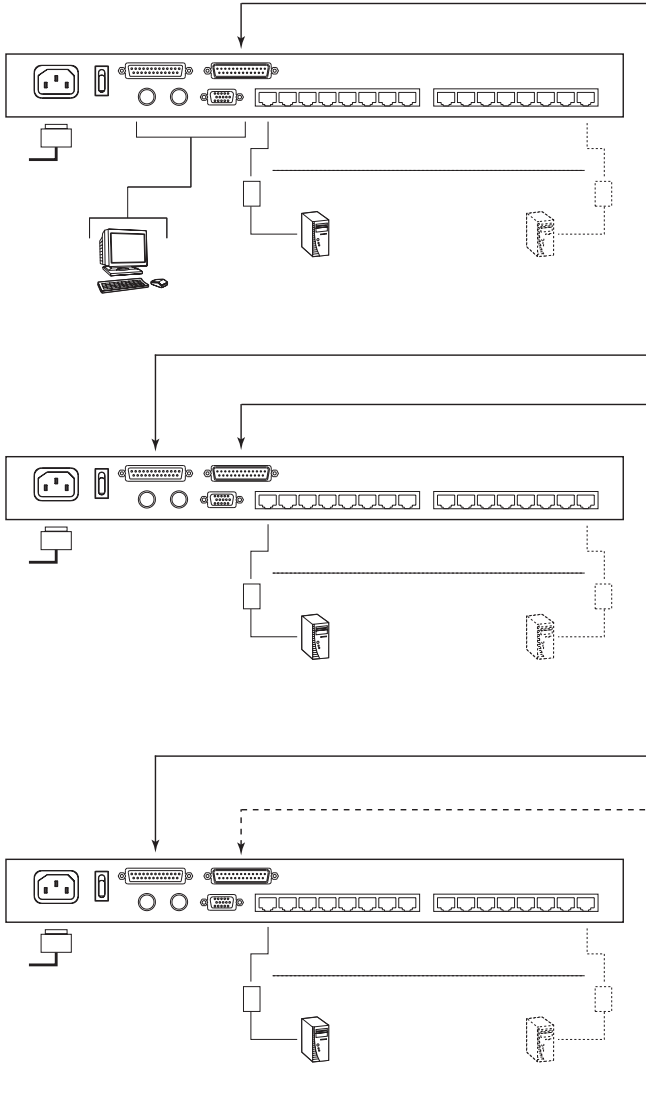

Chapter 3

Basic Operation

Port Selection

KH1508 / KH1516 installations provide three methods to obtain instant access to any computer in your installation: Manual, OSD, and *Hotkey*.

Manual

For manual port selection, simply press the Port Switch that corresponds to the device you wish to access.

For the cascaded switches, first press the Port Switch on the parent unit that the cascaded switch is connected to, then press the Port Switch on the cascaded switch that corresponds to the device you wish to access.

OSD

OSD (On Screen Display), provides a menu driven interface to the computer switching procedure. OSD operation is discussed in the next chapter.

Hotkey

Hotkeys allow you to conveniently provide KVM focus to a particular computer from the keyboard, instead of having to manually select them by pressing Port Selection switches. Hotkey operation is discussed in Chapter 5.

Hot Plugging

The KH1508 / KH1516 supports hot plugging – components can be removed and added back into the installation by unplugging and replugging their cables from their ports without the need to shut the unit down. In order for hot plugging to work properly, however, the procedures described below must be followed.

Hot Plugging Stations

You can switch station positions by simply unplugging from the old parent and plugging into a new one. After you do, in order for the OSD menus to correspond to the change, you must reset the OSD. See *RESET STATION IDS*, page 31, for details.

Hot Plugging KVM Ports

After switching KVM ports, in order for the OSD menus to correspond to the change, you must manually reconfigure the OSD information for the new Port information. See *F3 SET*, page 26, and the Port Setting selections under the *F4 ADM* function, page 28, for details.

Note: If the computer's Operating System doesn't support hot plugging, this function may not work properly.

Hot Plugging Console Ports:

Keyboard, monitor, and mouse can all be hot plugged. When hot plugging the mouse:

- ♦ You may unplug the mouse and plug it back in again (to reset the mouse, for example), as long as you use the *same* mouse.
- ♦ If you plug in a different mouse, all the stations and all the computers on the installation must be shut down for 10 seconds, then restarted following the Power Up Sequence described under Step 6 on page 15.)

Note: If, after hot plugging (or at any other time), there is no response to keyboard and/or mouse input, perform a Keyboard and Mouse Reset by pressing in the Reset switch (see page 7).

Powering Off and Restarting

If it becomes necessary to power off the KH1508 / KH1516, or if the switch loses power and needs to be restarted, before starting it back up you must follow these procedures:

1. Shut down all the computers that are attached to it.

Note: You must unplug the power cords of any computers that have the Keyboard Power On function.

2. Wait 10 seconds then power it back on. If you have shut down more than one station, power up the highest station first and work your way down to the lowest one. Wait for each station to display its Station ID on the front panel LED before powering on the next one.
3. After the station(s) is (are) up, power the computers back on.

Port ID Numbering

Each computer on the installation is assigned a unique Port ID. The Port ID is a one or two segment number that is determined by the Stage Level and KVM Port number of the KVM switch that the computer is connected to.

The first segment represents the KVM Port number of the First Stage unit; the second segment represents the KVM Port number of the Second Stage unit.

A computer attached to a First Stage unit has a one segment Port ID (from 1-16) that corresponds to the KVM Port number that it is connected to.

A computer attached to a Second Stage unit has a two segment Port ID:

- ◆ The second segment (from 1-8), represents the KVM Port number on the Second Stage unit that the computer is connected to. The first segment (from 1-16) represents the KVM Port number on the First Stage unit that the Second Stage unit links back to.
- ◆ For example, a Port ID of 12 - 3 refers to a computer that is connected to KVM Port 3 of a Second Stage unit that links back to KVM Port 12 of the First Stage unit.

This Page Intentionally Left Blank

Chapter 4

OSD Operation

Overview

The On Screen Display (OSD) is a menu driven method to handle computer control and switching operations. All procedures start from the OSD Main Screen. To pop up the Main Screen, tap [**Scroll Lock**] twice.

Note: You can optionally change the Hotkey to the Ctrl key, in which case you would tap [**Ctrl**] twice (see *OSD HOTKEY*, page 26). With this method, the Ctrl keys must be on the same side (both left, or both right).

The OSD incorporates a two level (Administrator / User) password system. Before the OSD Main Screen comes up, a dialog box appears that asks you to provide your password. If the password function has been set, you must provide the password in order to access the OSD Main Screen.

If this is the first time that the OSD is being run, or if the password function has not been set, simply press [**Enter**]. The OSD Main Screen comes up in Administrator Mode. In this mode, you have Administrator privileges, with access to all Administrator and User functions, and can set up operations (including password authorization for the future), as you would like.

When you invoke the OSD, a screen similar to the one below appears:

F1:GOTO		F3:SET		F5:SKP		F7:SCAN	
F2:LIST		F4:ADM				F8:LOUT	
ADMINISTRATOR							
LIST:ALL							
SN - PN	QV		⚙	NAME			
01 - 14	◀		⚙	ATEN INTL.CO. 1			
01 - 15				ATEN INTL.CO. 2			
01 - 16			⚙	ATEN INTL.CO. 3			
02 - 01	◀		⚙	FAX SERVER 1			
02 - 02				FAX SERVER 2			
02 - 03	◀		⚙	WEB SERVER 1			
02 - 04				WEB SERVER 2			
02 - 05	◀		⚙	MAIL SERVER 1			

-
- Note:**
1. The diagram depicts the Administrator's Main Screen. The User Main Screen does not show the **F4** function since it is reserved for the Administrator and can't be accessed by ordinary Users.
 2. The OSD always starts in *List* view, with the highlight bar at the same position it was in the last time it was closed.
 3. Only the ports that have been set accessible by the Administrator for the currently logged in User are visible (see *SET ACCESSIBLE PORTS*, page 30, for details).
-

OSD Navigation

- ◆ To dismiss the menu, and deactivate the OSD, press [Esc].
- ◆ To Logout, press [F8].
- ◆ To move up or down through the list one line at a time, use the Up and Down Arrow Keys. If there are more list entries than there is room for on the Main Screen, the screen will scroll.
- ◆ To move up or down through the list one screen at a time, use the [Pg Up] and [Pg Dn] keys. If there are more list entries than there is room for on the Main Screen, the screen will scroll.
- ◆ To bring the KVM focus to a port, move the Highlight Bar to it then press [Enter].
- ◆ After executing any action, you automatically go back to the menu one level above.

OSD Main Screen Headings

Heading	Explanation
SN-PN	This column lists the Port ID numbers (Station Number - Port Number) for all the Computer Ports on the installation. The simplest method to access a particular computer is move the Highlight Bar to it, then press Enter .
QV	If a port has selected for Quick View scanning (see <i>SET QUICK VIEW PORTS</i> , page 30), an arrowhead displays in this column to indicate so.
	The computers that are powered on and are On Line have a Sun symbol in this column to indicate so.
NAME	If a port has been given a name (see <i>EDIT PORT NAMES</i> , page 29), its name appears in this column.

OSD Functions

OSD functions are used to configure and control the OSD. For example, rapidly switching to any port; scanning only selected ports; limiting the list of ports you wish to view; designating a port as a Quick View Port; managing port names; or making OSD setting adjustments.

To access an OSD function:

1. Press a Function Key on the keyboard.
2. In the Submenus that appear, make your choice by moving the Highlight Bar to it, then pressing **[Enter]**.
3. Press **[Esc]** to return to the previous menu level.

F1 GOTO

Pressing **[F1]** activates the GOTO function. GOTO allows you to switch directly to a port either by keying in the port's *Name*, or its *Port ID*.

- ♦ To use the Name method, key in **1**; key in the port's Name; then press **[Enter]**.
- ♦ To use the Port ID method, key in **2**; key in the *Port ID*; then press **[Enter]**.

Note: You can key in a partial Name or Port ID. In that case, the screen will show all the computers that the User has *View* rights to (see *SET ACCESSIBLE PORTS*, page 30), that match the Name or Port ID pattern, regardless of the current List settings (see *F2 LIST*, page 25, for details).

To return to the OSD Main Screen without making a choice, press **[Esc]**.

F2 LIST

This function lets you broaden or narrow the scope of which ports the OSD displays (lists) on the Main Screen. Many of the OSD functions only operate on the computers currently selected for Listing on the Main Screen with this function. The submenu choices and their meanings are given in the table below:

Choice	Meaning
ALL	Lists all of the ports on the installation.
POWERED ON	Lists only the ports that have their attached computers Powered On.
QVIEW	Lists only the ports that have been selected as Quick View Ports (see <i>SET ACCESSIBLE PORTS</i> , page 30).
QVIEW + POWERED ON	Lists only the ports that have been selected as Quick View Ports (see <i>SET QUICK VIEW PORTS</i> , page 30, and that have their attached computers Powered On.

Move the Highlight Bar to the choice you want, then press **[Enter]**. An icon appears before the choice to indicate that it is the currently selected one.

F3 SET

This function allows the Administrator and each User to set up their own working environment. A separate profile for each is stored by the OSD and is activated according to the *Username* that is provided during Login.

To change a setting:

1. Move the highlight bar to it, then press **[Enter]**.
2. After you select an item, a submenu with further choices appears. To make a selection, move the Highlight Bar to it, then press **[Enter]**. An icon appears before the selected choice to indicate which one it is. The settings are explained in the following table:

Setting	Function
OSD HOTKEY	Selects which Hotkey activates the OSD function: [Scroll Lock] [Scroll Lock] or [Ctrl] [Ctrl] . Since the Ctrl key combination may conflict with programs running on the computers, the default is the Scroll Lock combination.
PORT ID DISPLAY POSITION	Allows you to position where the Port ID appears on the monitor. The default is the upper left corner, but you can have it appear anywhere on the screen. Use the Arrow Keys plus Pg Up, Pg Dn, Home, End, and 5 (on the numeric keypad with Num Lock off), to position the Port ID display, then press [Enter] to lock the position and return to the Set submenu.
PORT ID DISPLAY DURATION	Determines how long a Port ID displays on the monitor after a port change has taken place. The choices are: User Defined - which lets you select the amount of time (from 1 - 255 sec.); and Always On - which displays the Port ID at all times. If you select <i>User Defined</i> , key in the number of seconds, then press [Enter] . The default is 3 Seconds. A setting of 0 (zero) disables this function.

(Continues on next page.)

(Continued from previous page.)

Setting	Function
PORT ID DISPLAY MODE	Selects how the Port ID is displayed: the Port Number alone (PORT NUMBER); the Port Name alone (PORT NAME); or the Port Number plus the Port Name (PORT NUMBER + PORT NAME). The default is PORT NUMBER + PORT NAME).
SCAN DURATION	Determines how long the focus dwells on each port as it cycles through the selected ports in Auto Scan Mode (see <i>F7 SCAN</i> , page 33). Key in a value from 1 - 255 seconds, then press [Enter] . Default is 5 seconds; a setting of 0 disables the Scan function.
SCAN/SKIP MODE	<p>Selects which computers will be accessed under Skip Mode (see <i>F5 SKP</i>, page 32), and Auto Scan Mode (see <i>F7 SCAN</i>, page 33). Choices are:</p> <p>ALL - All the Ports which have been set Accessible (see <i>SET ACCESSIBLE PORTS</i>, page 30);</p> <p>POWERED ON - Only those Ports which have been set Accessible and are Powered On;</p> <p>QUICK VIEW - Only those Ports which have been set Accessible and have been selected as Quick View Ports (see <i>SET QUICK VIEW PORTS</i>, page 30);</p> <p>QUICK VIEW + POWERED ON - Only those Ports which have been set Accessible and have been selected as Quick View Ports and are Powered On.</p> <p>The default is ALL.</p>
SCREEN BLANKER	If there is no input from the console for the amount of time set with this function, the screen is blanked. Key in a value from 1 - 30 minutes, then press [Enter] . A setting of 0 disables this function. The default is 0 (disabled).
HOTKEY COMMAND MODE	Enables / Disables the Hotkey Command function in case a conflict with programs running on the computers occurs. The default is ON.

F4 ADM

F4 is an Administrator only function. It allows the Administrator to configure and control the overall operation of the OSD. To change a setting use the Up and Down Arrow Keys to move the highlight bar to it then press **[Enter]**.

After you select an item, a submenu with further choices appears. Move the Highlight Bar to the choice you want, then press **[Enter]**. An icon appears before the selected choice so that you know which one it is. The settings are explained in the following table:

Setting	Function
SET USERNAME AND PASSWORD	<p>This function is used to set Usernames and Passwords for the Administrator and Users:</p> <ol style="list-style-type: none"> 1. One Administrator and four User passwords can be set. 2. After you select the Administrator field or one of the User fields, a screen that allows you to key in your password appears. The password may be up to 15 characters long, and can consist of any combination of letters and numbers (A - Z, 0 - 9). 3. For each individual, key in the Username and Password, then press [Enter]. 4. To modify or delete a previous Username and/or Password, use the backspace key to erase individual letters or numbers.
SET LOGOUT TIMEOUT	<p>If there is no input from the console for the amount of time set with this function, the Operator is automatically logged out. A login is necessary before the console can be used again.</p> <p>This enables other Operators to gain access to the computers when the original Operator is no longer accessing them, but has forgotten to log out. To set the timeout value, key in a number from 1 - 180 minutes, then press [Enter]. If the number is 0 [zero], this function is disabled. Default is 0 (disabled).</p>

(Continues on next page.)

(Continued from previous page.)

Setting	Function
EDIT PORT NAMES	<p>To help remember which computer is attached to a particular port, every port can be given a name. This function allows the Administrator to create, modify, or delete port names. To Edit a port name:</p> <ol style="list-style-type: none"> 1. Use the Navigation Keys to move the highlight bar to the port you want, then press [Enter]. 2. Key in the new Port Name, or modify/delete the old one. The maximum number of characters allowed for the Port Name is 12. Legal characters include: <ul style="list-style-type: none"> ◆ All alpha characters: a - z; A - Z ◆ All numeric characters: 0 - 9 ◆ + - / . and Space <p>Case does not matter; the OSD displays the Port Name in all capitals no matter how they were keyed in.</p> 3. When you have finished editing, press [Enter] to have the change take effect. To abort the change, press [Esc].
RESTORE DEFAULT VALUES	<p>This function is used to undo all changes and return the setup to the original factory default settings (see <i>OSD Factory Default Settings</i>, page 54) - except for the <i>Names</i> settings that were assigned to the Ports, which are saved.</p>
CLEAR THE NAME LIST	<p>This function is similar to Restore Default Values. The difference is that it also clears the <i>Names</i> settings along with undoing all changes and returning the setup to the original factory default settings.</p>
ACTIVATE BEEPER	<p>Choices are: Y (ON), or N (OFF).</p> <p>When activated, the beeper sounds whenever a Port is changed; when activating the Auto Scan function (see <i>F7 SCAN</i>, page 33); or an invalid entry is made on an OSD menu. The default is Y.</p>

(Continues on next page.)

(Continued from previous page.)

Setting	Function
SET QUICK VIEW PORTS	<p>This function lets the Administrator select which Ports to include as Quick View ports.</p> <ul style="list-style-type: none"> ◆ To select/deselect a port as a Quick View Port, use the Navigation Keys to move the highlight bar to it, then press [Enter]. ◆ When a port has been selected as a Quick View Port, an arrowhead displays in the QV column of the LIST on the Main Screen to indicate so. When a port is deselected, the arrowhead disappears. ◆ If one of the Quick View options is chosen for the LIST view (see <i>F2 LIST</i>, page 25), only a Port that has been selected here will display on the List. ◆ If one of the Quick View options is chosen for Auto Scanning (see <i>SCAN/SKIP MODE</i>, page 27), only a Port that has been selected here will be Auto Scanned. <p>The default is for no ports to be selected.</p>
SET ACCESSIBLE PORTS	<p>This function allows the Administrator to define User access to the computers on the installation on a Port-by-Port basis.</p> <p>For each User, select the target Port; then press the [Spacebar] to cycle through the choices:</p> <p>F (Full access)</p> <p>V (View Only), or</p> <p>Blank (A blank setting means that no access rights are granted. The Port will not show up on the User's LIST on the Main Screen.)</p> <p>Repeat until all access rights have been set, then press [Enter].</p> <p>The default is F for all users on all Ports.</p>

(Continues on next page.)

(Continued from previous page.)

Setting	Function
RESET STATION IDS	<p>If you change the position of one of the Stations in the daisy chain, the OSD settings will no longer correspond to the new situation. This function directs the OSD to rescan the Station positions of the entire installation and updates the OSD so that the OSD Station information corresponds to the new physical layout.</p> <p>Only the Station Numbers get updated. Except for the Port Names, all Administrator settings (such as Set Accessible Ports, Set Quick View Ports, etc.), for all of the computers affected by the change, have to be manually redone.</p>
FIRMWARE UPGRADE	<p>In order to upgrade the KH1508 / KH1516's firmware (see <i>KH1508 / KH1516 Upgrade</i>, page 43), you must first invoke Firmware Upgrade Mode with this setting.</p>
PORT SETTING	<p>This screen lets you set three functions for the port: the length of the Cat 5 cable from the port to the KVM Adapter; the Operating System used by the computer connected to the port; and the Keyboard Language for the computer connected to the port.</p> <ul style="list-style-type: none"> ◆ Press [Spacebar] to cycle through the cable length settings: <ul style="list-style-type: none"> S: Short – for up to 25 m M: Medium – for between 20 and 40 m L: Long – for above 35 m <p>An S, M, or L appears next to the port in the L column to indicate the choice.</p> ◆ Press [Enter] to cycle through the Operating System settings: PC, Mac, or Sun. ◆ Press [Tab] to cycle through the Keyboard Language settings: USA, GBR, FRA, JPN, KOR. <p>Note: For German or Chinese, select USA.</p>
ADAPTER UPGRADE	<p>In order to upgrade the Adapter Cables' firmware (see <i>Adapter Cable Upgrade</i>, page 49), you must first invoke its Upgrade Mode with this setting.</p>

F5 SKP

Pressing **[F5]** invokes Skip (SKP) Mode. This function enables you to easily skip backward or forward - switching the console focus from the currently active computer port to the previous or next available one.

- ◆ The selection of computers to be available for Skip Mode switching is made with the *Scan/Skip Mode* setting under the **F3 SET** function (see page 26).
- ◆ When you are in Skip Mode, press [←] to switch to the previous computer in the List; press [→] to switch to the next computer in the List; press [↑] to switch to the last computer on the previous station in the List; press [↓] to switch to the first computer on the next station in the List.

Note: When you Skip, you only Skip to the previous or next available computer that is in the *Scan/Skip Mode* selection (see page 27).

- ◆ If a Port has been selected for *Scan/Skip Mode*, when the focus switches to that port a Left/Right Triangle symbol appears before its Port ID Display to indicate so.
- ◆ While Skip Mode is in effect, the console will not function normally. You must exit Skip Mode in order to regain control of the console.
- ◆ To exit Skip Mode, press **[Spacebar]** or **[Esc]**.

F7 SCAN

Pressing **[F7]** invokes Auto Scan Mode. This function allows you to automatically switch among the available computers at regular intervals so that you can monitor their activity without having to take the trouble of switching manually.

- ◆ The selection of computers to be included for Auto Scanning is made with the *Scan/Skip Mode* setting under the **F3 SET** function (see page 26).
- ◆ The amount of time that each Port displays for is set with the *Scan Duration* setting under the **F3 SET** function (see page 26). When you want to stop at a particular location, press the **[Spacebar]** to stop scanning and exit *Auto Scan Mode*.
- ◆ If the scanning stops on an empty port, or one where the computer is attached but is powered Off, the monitor screen will be blank, and the mouse and keyboard will have no effect. Simply wait - after the *Scan Duration* time is up, the Scan function will move on to the next port.
- ◆ As each computer is accessed, an **S** appears in front of the Port ID display to indicate that it is being accessed under *Auto Scan Mode*.
- ◆ While Auto Scan Mode is in effect, the console will not function normally. You must exit Auto Scan Mode in order to regain control of the console.
- ◆ While you are in Auto Scan Mode, you can pause the scanning in order to keep the focus on a particular computer by pressing **P**. See *Invoking Auto Scan*, page 37, for details.
- ◆ To exit Auto Scan Mode, press **[Spacebar]** or **[Esc]**.

F8 LOUT

Pressing **[F8]** logs you out of OSD control of the computers, and blanks the Console screen. This is different from simply pressing **[Esc]** when you are at the Main Screen to deactivate the OSD. With this function you must log in all over again to regain access to the OSD, whereas with **[Esc]**, all you have to do to reenter the OSD is tap the OSD Hotkey.

-
- Note:**
1. When you reenter the OSD after logging out, the screen stays blank except for the OSD Main Screen. You must input your password before you can continue.
 2. If you reenter the OSD after logging out, and immediately use **[Esc]** to deactivate the OSD without having selected a port from the OSD menu, a Null Port message displays on the screen. The OSD Hotkey will bring up the Main OSD Screen.
-

Chapter 5

Hotkey Operation

Hotkey Port Control

Hotkey Port Control allows you to provide KVM focus to a particular computer directly from the keyboard. The KH1508 / KH1516 provides the following Hotkey Port Control features:

- ♦ Selecting the Active Port
- ♦ Auto Scanning
- ♦ Skip Mode Switching

Invoking Hotkey Mode

All Hotkey operations begin by invoking *Hotkey Mode*. Invoking Hotkey Mode takes three steps:

1. Hold down the **Num Lock** key;
2. Press and release the **minus** key;
3. Release the **Num Lock** key:

[Num Lock] + [-];

Note: The minus key must be released within one half second, otherwise Hotkey invocation is cancelled and it has no effect.

When Hotkey Mode is active:

- ♦ The Caps Lock, and Scroll Lock LEDs flash in succession to indicate so. They stop flashing and revert to normal status when you exit Hotkey Mode.
- ♦ A Command Line appears on the monitor screen. The command line prompt is the word *Hotkey:* in yellow text on a blue background, and displays the subsequent Hotkey information that you key in.
- ♦ Ordinary keyboard and mouse functions are suspended - only Hotkey compliant keystrokes (described in the sections that follow), can be input.

Pressing [**Esc**] exits Hotkey Mode.

Selecting the Active Port

Each Computer Port is assigned a Port ID (see *Port ID Numbering*, page 19). You can directly access any computer on the installation with a Hotkey combination that specifies the Port ID of the Computer Port that the computer is connected to. The steps involved are:

1. Invoke Hotkey Mode (see page 35).
2. Key in the Port ID
The Port ID numbers display on the Command Line as you key them in. If you make a mistake, use [Backspace] to erase the wrong number.
3. Press [**Enter**]
After you press [Enter], the KVM focus switches to the designated computer and you automatically exit Hotkey Mode.

Auto Scanning

Auto Scan automatically switches among all the active Computer Ports that are accessible to the currently logged on User at regular intervals, so that he can monitor their activity automatically. (See *SCAN/SKIP MODE* of the OSD **F3 SET** function, page 27 for information regarding accessible ports).

Setting the Scan Interval

The amount of time Auto Scan dwells on each port is set with the *SCAN DURATION* setting of the OSD **F3 SET** function (see page 27). You can change the scan interval before activating Hotkey Auto Scanning, if you wish, with the following Hotkey combination:

1. Invoke Hotkey Mode (see page 35).
2. Key in [**T**] [**n**]
Where [**T**] is the letter **T**, and [**n**] is a number from 1-255 that represents the number of seconds for the dwell time.

The letter **T** and the numbers display on the Command Line as you key them in. If you make a mistake, use [**Backspace**] to erase the wrong number.
3. Press [**Enter**]
After you press [Enter], you automatically exit Hotkey Mode, and are ready to invoke Auto Scanning.

Invoking Auto Scan

To start Auto Scanning, key in the following Hotkey combination:

1. Invoke Hotkey Mode (see page 35).
2. Press **[A]**.

After you press **A**, you automatically exit Hotkey Mode, and enter Auto Scan Mode, and Auto Scanning begins.

- ◆ While you are in Auto Scan Mode, you can pause the scanning in order to keep the focus on a particular computer by pressing **P**. During the time that Auto Scanning is paused, the Command Line displays: **Auto Scan: Paused**.

Pausing when you want to keep the focus on a particular computer is more convenient than Exiting Auto Scan Mode because when you Resume scanning, you start from where you left off. If, on the other hand, you Exited and restarted, Scanning would start over from the very first computer on the installation.

To resume Auto Scanning, press any key. Scanning continues from where it left off.

- ◆ While Auto Scan Mode is in effect, ordinary keyboard and mouse functions are suspended - only Auto Scan Mode compliant keystrokes can be input. You must exit Auto Scan Mode in order to regain normal control of the console.
3. To exit Auto Scan Mode press **[Esc]** or **[Spacebar]**. Auto Scanning stops when you exit Auto Scan Mode.

Skip Mode

This feature allows you to switch between computers in order to monitor them manually. You can dwell on a particular port for as long or as little as you like - as opposed to Auto Scanning, which automatically switches after a fixed interval. To invoke Skip Mode, key in the following Hotkey combination:

1. Invoke Hotkey Mode (see page 35).
2. Key in **[Arrow]**
 - ◆ Where [Arrow] refers to one of the Arrow keys. After you press [Arrow], you automatically exit Hotkey Mode, and enter Skip Mode where you can switch ports as follows:
 - ← Skips from the current port to the first accessible port previous to it. (See *SCAN/SKIP MODE*, page 27, for information regarding accessible ports.)
 - Skips from the current port to the next accessible port.
 - ↑ Skips from the current port to the last accessible port of the previous Station.
 - ↓ Skips from the current port to the first accessible port of the next Station.
 - ◆ Once you are in Skip Mode, you can keep on skipping by pressing the Arrow keys. You don't have to use the [NumLock] + [-] combination again.
 - ◆ While Skip Mode is in effect, ordinary keyboard and mouse functions are suspended - only Skip Mode compliant keystrokes can be input. You must exit Skip Mode in order to regain normal control of the console.
3. To exit Skip Mode, press **[Esc]** or **[Spacebar]**.

Hotkey Beeper Control

The Beeper (see *ACTIVATE BEEPER*, page 29) can be Hotkey toggled On and Off. To toggle the Beeper, key in the following Hotkey combination:

1. Invoke Hotkey Mode (see page 35).
2. Press [**B**]

After you press **B**, the Beeper toggles On or Off. The Command Line displays *Beeper On* or *Beeper Off* for one second; then the message disappears and you automatically exit Hotkey Mode.

Hotkey Summary Table

The following table summarizes Hotkey operations on the KH1508 / KH1516:

[Num Lock] + [-]	[Port ID] [Enter]	Switches access to the computer that corresponds to that Port ID.
	[T] [n] [Enter]	Sets the Auto Scan interval to n seconds - where n is a number from 1 - 255.
	[A]	Invokes Auto Scan Mode. When Auto Scan Mode is in effect, [P] pauses Auto Scanning. When Auto Scanning is paused, pressing any key resumes Auto Scanning.
	[←]	Invokes Skip Mode and skips from the current port to the first accessible port previous to it.
	[→]	Invokes Skip Mode and skips from the current port to the next accessible port.
	[↑]	Invokes Skip Mode and skips from the current port to the last accessible port of the previous Station.
	[↓]	Invokes Skip Mode and skips from the current port to the first accessible port of the next Station.
	[B]	Toggles the Beeper On or Off.









This Page Intentionally Left Blank

Chapter 6

Keyboard Emulation

Mac Keyboard







The PC compatible (101/104 key) keyboard can emulate the functions of the Mac keyboard. The emulation mappings are listed in the table below.

PC Keyboard	Mac Keyboard
[Shift]	Shift
[Ctrl]	Ctrl
	
[Ctrl] [1]	
[Ctrl] [2]	
[Ctrl] [3]	
[Ctrl] [4]	
[Alt]	Alt
[Print Screen]	F13
[Scroll Lock]	F14
	=
[Enter]	Return
[Backspace]	Delete
[Insert]	Help
[Ctrl] 	F15

Note: When using key combinations, press and release the first key (Ctrl), then press and release the activation key.

Sun Keyboard

The PC compatible (101/104 key) keyboard can emulate the functions of the Sun keyboard when the Control key [Ctrl] is used in conjunction with other keys. The corresponding functions are shown in the table below.

PC Keyboard	Sun Keyboard
[Ctrl] [T]	Stop
[Ctrl] [F2]	Again
[Ctrl] [F3]	Props
[Ctrl] [F4]	Undo
[Ctrl] [F5]	Front
[Ctrl] [F6]	Copy
[Ctrl] [F7]	Open
[Ctrl] [F8]	Paste
[Ctrl] [F9]	Find
[Ctrl] [F10]	Cut
[Ctrl] [1]	
[Ctrl] [2]	
[Ctrl] [3]	
[Ctrl] [4]	
[Ctrl] [H]	Help
	Compose
	

Note: When using key combinations, press and release the first key (Ctrl), then press and release the activation key.

Chapter 7

Firmware Upgrade

KH1508 / KH1516 Upgrade

Introduction

As new firmware revisions become available for the KH1508 / KH1516, new firmware upgrade packages are posted on our web site:

<http://www.aten.com/support>

Check the web site regularly to find the latest packages and information relating to them.

Before You Begin

To prepare for the firmware upgrade, do the following:

1. From a computer that is not part of your KVM installation go to our Internet support site and choose the model name that relates to your device to get a list of available Firmware Upgrade Packages.
2. Choose the Firmware Upgrade Package you want to install (usually the most recent), and download it to your computer.
3. Use the *Firmware Upgrade Cable* (provided with this unit), to connect a COM port on your computer to the *Firmware Upgrade Port* of your device.

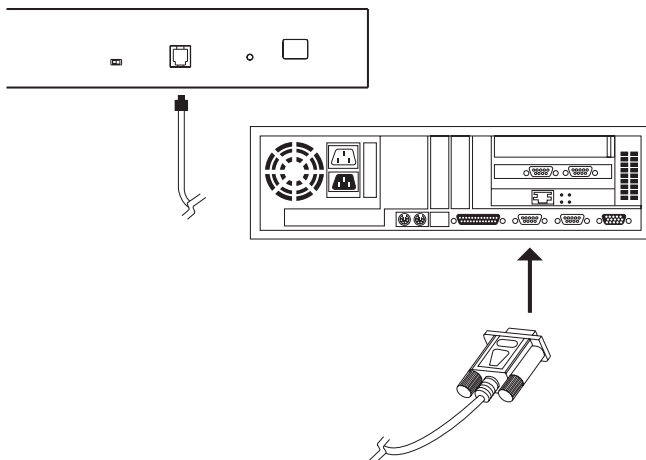

Note: On a daisy chained installation, connect the cable to the First Station (Master) unit. The chained stations (Slaves) will receive the upgrade via the daisy chain cables.

4. Shut down all of the computers - but not the Stations - on your KVM installation.
5. From your KVM switch console, bring up the OSD (see page 21) and select the **F4ADM** function.
6. Scroll down to *FIRMWARE UPGRADE*. Press [**Enter**], then press [**Y**] to invoke Firmware Upgrade Mode. (see page 31.) For your reference, the current firmware upgrade version displays on the screen.

Performing the Upgrade

Starting the Upgrade:

To upgrade your firmware:

1. Run the downloaded Firmware Upgrade Package file - either by double clicking the file icon, or by opening a command line and keying in the full path to it.

The Firmware Upgrade Utility *Welcome* screen appears:

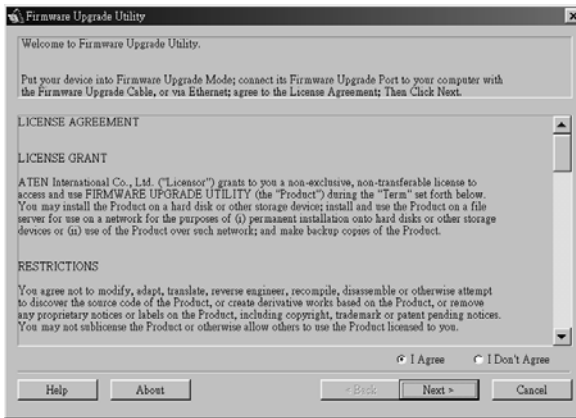

2. Read and *Agree* to the License Agreement (enable the I Agree radio button).

3. Click **Next** to continue. The Firmware Upgrade Utility main screen appears:

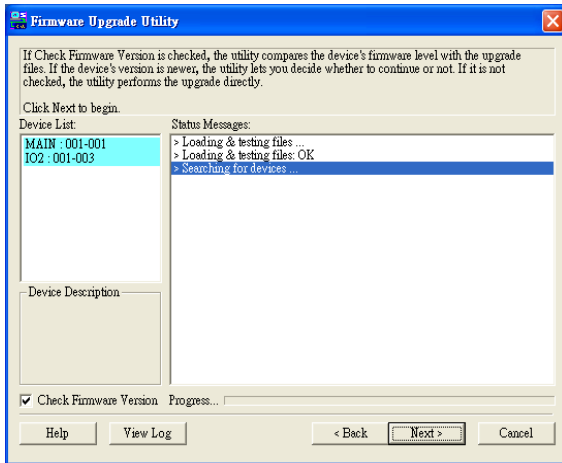

The Utility inspects your installation. All the devices capable of being upgraded by the package are listed in the *Device List* panel.

4. After you have made your selection(s), Click **Next** to perform the upgrade.
- ◆ If you enabled *Check Firmware Version*, the Utility compares the device's firmware level with that of the upgrade files. If it finds that the device's version is higher than the upgrade version, it brings up a dialog box informing you of the situation and gives you the option to Continue or Cancel:

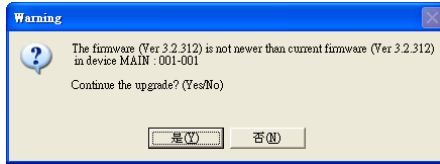

If you didn't enable *Check Firmware Version*, the Utility installs the upgrade files without checking whether they are a higher level, or not.

- ◆ As the Upgrade proceeds status messages appear in the Status Messages panel, and the progress toward completion is shown on the *Progress* bar.
- ◆ To abort the upgrade procedure before it completes, click **Cancel**.

If you cancel before completion, a dialog box appears warning you that quitting at this point may cause the device's firmware to be lost, and you are given the option to proceed or abort the cancel operation.

To recover from a "lost firmware" situation, see *Firmware Upgrade Recovery*, page 48.

Upgrade Succeeded:

After the upgrade has completed, a screen appears to inform you that the procedure was successful:

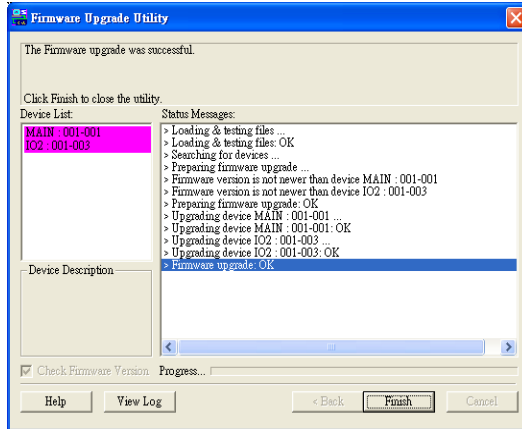

Click **Finish** to close the Firmware Upgrade Utility.

Upgrade Failed:

If the upgrade failed to complete successfully a dialog box appears asking if you want to retry. Click **Yes** to retry. If you Click **No**, the *Upgrade Failed* screen appears:

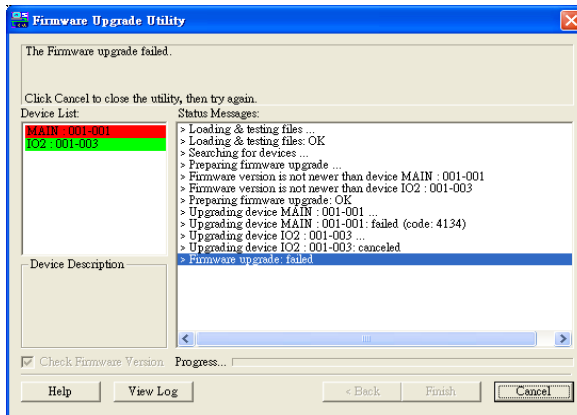

Click **Cancel** to close the Firmware Upgrade Utility. See the next section, *Firmware Upgrade Recovery*, for how to proceed.

Firmware Upgrade Recovery

There are basically four conditions that call for firmware upgrade recovery:

- ◆ When the unit's firmware becomes corrupted for some reason and you are unable to operate it.
- ◆ When you invoke Firmware Upgrade Mode (see *FIRMWARE UPGRADE*, page 31), but decide not to proceed with the upgrade.
- ◆ When a firmware upgrade procedure is interrupted.
- ◆ When a firmware upgrade procedure fails.

To perform a firmware upgrade recovery, do the following:

1. Slide the *Firmware Upgrade Recovery Switch* (see page 7) to the **Recover** position.
2. Power off and restart the switch according to the instructions given in the *Powering Off and Restarting* section (see page 19).
3. Slide the *Firmware Upgrade Recovery Switch* back to the **Normal** position.
4. Repeat Step 2.

Note: If one of the child units fails to upgrade successfully, unchain it from the installation and perform the recovery and upgrade operation on it independently. After it has been successfully upgraded, plug it back into the chain

Adapter Cable Upgrade

Introduction

The firmware for the KA9520, KA9570, and KA9130 KVM Adapter Cables can also be upgraded. Check the web site regularly to find the latest packages and information relating to them:

<http://www.aten.com/support>

Before You Begin

To prepare for the firmware upgrade, do the following:

1. From a computer that is not part of your KVM installation go to our Internet support site and choose the model name that relates to your device to get a list of available Firmware Upgrade Packages.
2. Choose the Firmware Upgrade Package you want to install (usually the most recent), and download it to your computer.

Note: The upgrade files for the three adapter cables aren't packaged separately. A single upgrade package provides the upgrade files for all of them.

3. Shut down all of the computers - but not the Stations - on your KVM installation.
4. From your KVM switch console, bring up the OSD (see page 21) and select the **F4ADM** function.
5. Scroll down to *ADAPTER UPGRADE*. Press **[Enter]**.
6. In the screen that comes up, press **[Y]** to invoke Upgrade Mode (see page 31).

Note: 1. A message appears reminding you to connect an adapter cable. The message appears even if you have adapter cables connected. If all the adapter cables you want to upgrade have already been connected, simply ignore the message.

2. The upgrade takes place via the Cat 5 cable that connects the adapter cable to the KVM switch - so there is no firmware upgrade cable to attach.
 3. All the connected adapter cables get upgraded during a single upgrade session.
-

Performing the Upgrade

Starting the Upgrade:

To upgrade your firmware:

1. Run the downloaded Firmware Upgrade Package file - either by double clicking the file icon, or by opening a command line and keying in the full path to it.

The Firmware Upgrade Utility *Welcome* screen appears (see page 44).

2. Read and *Agree* to the License Agreement (enable the I Agree radio button), then Click **Next** to continue. The Firmware Upgrade Utility main screen appears:

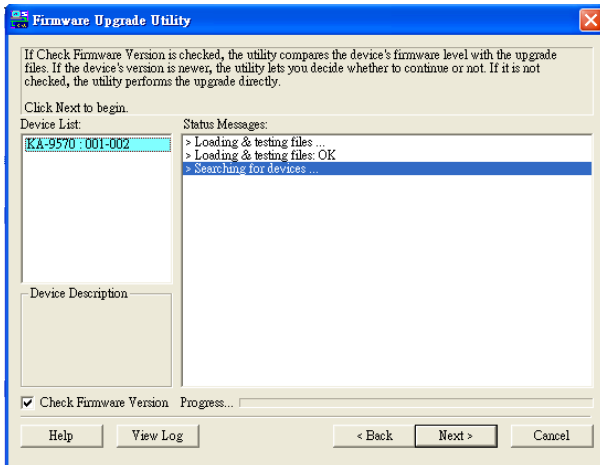

The Utility inspects your installation. All the devices capable of being upgraded by the package are listed in the *Device List* panel.

3. After all the devices have been listed, click **Next** to perform the upgrade. If you enabled *Check Firmware Version*, the Utility compares the device's firmware level with that of the upgrade files. If it finds that the device's version is higher than the upgrade version, it brings up a dialog box informing you of the situation and gives you the option to Continue or Cancel.

If you didn't enable *Check Firmware Version*, the Utility installs the upgrade files without checking whether they are a higher level, or not.

As the Upgrade proceeds status messages appear in the Status Messages panel, and the progress toward completion is shown on the *Progress* bar.

Upgrade Succeeded:

After the upgrade has completed, a screen appears to inform you that the procedure was successful:

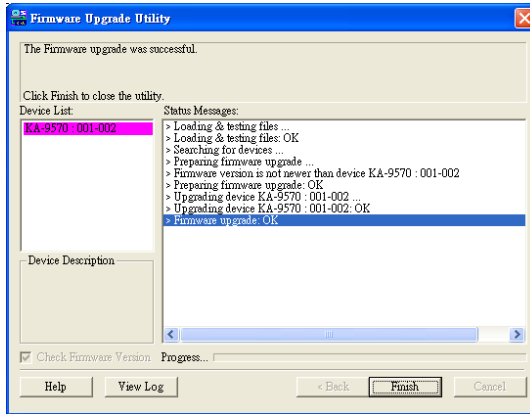

Click **Finish** to close the Firmware Upgrade Utility.

Note: At the completion of the upgrade the KH1508 / KH1516 restarts.

Firmware Upgrade Recovery

There are basically four conditions that call for firmware upgrade recovery:

- ◆ When the unit's firmware becomes corrupted for some reason and you are unable to operate it.
- ◆ When you invoke Adapter Upgrade Mode (see *ADAPTER UPGRADE*, page 31), but decide not to proceed with the upgrade.
- ◆ When a firmware upgrade procedure is interrupted.
- ◆ When a firmware upgrade procedure fails.

To perform a firmware upgrade recovery, do the following:

1. Unplug the Adapter Cable from the computer it is connected to.
2. Slide its *Firmware Upgrade Recovery Switch* (located next to the Cat 5 connector) to the **Recover** position.
3. Plug the adapter cable back into the computer.
4. From your KVM switch console, bring up the OSD (see page 21) and select the **F4ADM** function.
5. Scroll down to *ADAPTER UPGRADE*. Press [**Enter**].
6. Press [**Y**] to invoke Upgrade Mode (see page 31).
7. Proceed with the firmware upgrade as described in *Performing the Upgrade*, starting on page 50.
8. After the upgrade completes and the switch restarts, unplug the Adapter Cable from the computer and slide the *Firmware Upgrade Recovery Switch* back to the **Normal** position.
9. Plug the adapter cable back into the computer.

This completes the recovery procedure.

Appendix

Connection Tables

The following table indicates the relationship between the number of KH1508 / KH1516 units and the number of computers that they control

KH1508

MVs	Computers	MVs	Computers	MVs	Computers	MVs	Computers
1	1 - 8	9	65 - 72	17	129 - 136	25	193 - 200
2	9 - 16	10	73 - 80	18	137 - 144	26	201 - 208
3	17 - 24	11	81 - 88	19	145 - 152	27	209 - 216
4	25 - 32	12	89 - 96	20	153 - 160	28	217 - 224
5	33 - 40	13	97 - 104	21	161 - 168	29	225 - 232
6	41 - 48	14	105 - 112	22	169 - 176	30	233 - 240
7	49 - 56	15	113 - 120	23	177 - 184	31	241 - 248
8	57 - 64	16	121 - 128	24	185 - 192	32	249 - 256

KH1516

MVs	Computers	MVs	Computers	MVs	Computers	MVs	Computers
1	1 - 16	9	129 - 144	17	257 - 272	25	385 - 400
2	17 - 32	10	145 - 160	18	273 - 288	26	401 - 416
3	33 - 48	11	161 - 176	19	289 - 304	27	417 - 432
4	49 - 64	12	177 - 192	20	305 - 320	28	433 - 448
5	65 - 80	13	193 - 208	21	321 - 336	29	449 - 464
6	81 - 96	14	209 - 224	22	337 - 352	30	465 - 480
7	97 - 112	15	225 - 240	23	353 - 368	31	481 - 496
8	113 - 128	16	241 - 256	24	369 - 384	32	497 - 512

OSD Factory Default Settings

Setting	Default
OSD Hotkey	[Scroll Lock] [Scroll Lock]
Port ID Display Position	Upper Left Corner
Port ID Display Duration	3 Seconds
Port ID Display Mode	The Port Number plus the Port Name
Scan Duration	5 Seconds
Scan/Skip Mode	All
Screen Blanker	0 (Disabled)
Hotkey Command Mode	On
Set Logout Timeout	0 (Disabled)
Restore Default Values	N
Clear the Name List	N
Activate Beeper	ON
Set Accessible Ports	F (Full) For all Users on all Ports
Firmware Upgrade	N

Specifications

Function		KH1508	KH1516	
Computer Connections	Direct	8	16	
	Max.	256 (via Daisy Chain)	512 (via Daisy Chain)	
Port Selection		OSD (On Screen Display); Hotkeys Pushbutton Switches		
Connectors	Console	KB	1 x 6-pin Mini-DIN F (Purple)	
		Video	1 x HDB-15 F	
		Mouse	1 x 6-pin Mini-DIN F (Green)	
	KVM Ports		8 x RJ-45	16 x RJ-45
	Daisy Chain		1 x DB-25 F; 1 x DB-25 M	
	F/W Upgrade		1 x RJ-11	
	Power		3-Prong AC socket	
Switches	Port Selection	8 x Pushbutton	16 x Pushbutton	
	Reset	1 x Semi-recessed pushbutton		
	F/W Upgrade	1 x Slide		
	Power	1 x Rocker		
LEDs	On Line	8 (Green)	16 (Green)	
	Selected	8 (Orange)	16 (Orange)	
	Power	1 (Blue)		
	Station ID	2 x 7-segment (Orange)		
I/P Rating		AC 100–240V; 50/60 Hz		
Power Consumption		25 W	27W	
Emulation	Keyboard / Mouse	PS/2		
Scan Interval		1–255 secs.		
Video		1600 x 1200 @ 60Hz (30m); 1280 x 1024 @ 60Hz (40m); DDC2B		
Environment	Operating Temp.	0–50° C		
	Storage Temp.	-20–60° C		
	Humidity	0–80% RH		
Physical Properties	Housing	Metal		
	Weight	2.7 kg		
	Dimensions	43.70 x 16.10 x 4.40 cm		

Administrator Login Failure

If you are unable to perform an Administrator login (because the Username and Password information has become corrupted or you have forgotten it, for example) you can clear the login information with the following procedure:

1. Power off the KH1508 / KH1516 and remove its housing.
2. Short the jumper labeled **J8**.

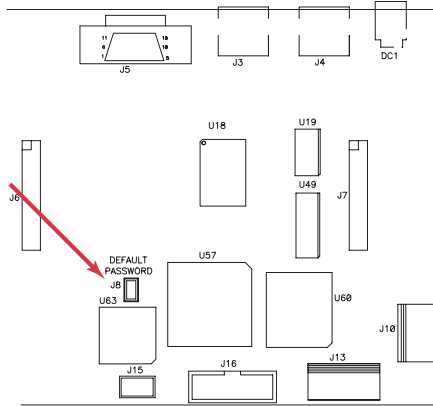

3. Power on the switch.
The on screen display will show a message informing you that the password information has been cleared.
4. Power off the switch.
5. Remove the jumper cap from **J8**.
6. Close the housing and start the KH1508 / KH1516 back up.

After you start back up, you can use the default Username and Password (see *Overview*, page 21) to log in.

Troubleshooting

Symptom	Possible Cause	Action
Mouse and/or Keyboard not responding.	Improper mouse and/or keyboard reset.	Unplug the cable(s) from the console port(s), then plug it/them back in.
All Station IDs display as 01.	Station 1 has suddenly lost power.	Wait a few seconds for the system to reinitialize the station sequence and display the proper IDs.

Limited Warranty

IN NO EVENT SHALL THE DIRECT VENDOR'S LIABILITY EXCEED THE PRICE PAID FOR THE PRODUCT FROM THE DIRECT, INDIRECT, SPECIAL, INCIDENTAL OR CONSEQUENTIAL DAMAGES RESULTING FROM THE USE OF THE PRODUCT, DISK OR ITS DOCUMENTATION.

The direct vendor makes no warranty or representation, expressed, implied, or statutory with respect to the contents or use of this documentation, and specially disclaims its quality, performance, merchantability, or fitness for any particular purpose.

The direct vendor also reserves the right to revise or update the device or documentation without obligation to notify any individual or entity of such revisions, or update. For further inquires please contact your direct vendor.

This Page Intentionally Left Blank

Index

A

- Activate Beeper, 29
- Adapter cable installation, 14
- ADM, 28
- Administrator functions, 28
- Administrator Login Failure, 56
- ALTUSEN Information, xiii
- Auto Scanning, 33, 36
 - Invoking Auto Scan, 37
 - Pausing Auto Scan, 37
 - Scan Duration, 27
 - Setting the Scan Interval, 36
 - Stopping, 37

B

- Beeper
 - Activate, 29
 - Hotkey Control, 39

C

- Clear the Name List, 29
- Components
 - Front View, 6
 - Rear View, 8
- Connection Tables, 53

D

- Daisy Chaining, 15

E

- Edit Port Names, 29

F

- Factory Default Settings, 54
- FCC Information, ii
- Features, 3

- Firmware upgrade, 43

- cable, 43
- port, 43
- recovery, 48, 52

- Firmware upgrade mode
 - invoking, 44

- Front View, 6

G

- GOTO, 24

H

- Hardware Setup, 9

- Hot Plugging
 - Stations, 18

- Hotkey

- Beeper Control, 39
- Command Mode, 27
- OSD, 26

- Port Control, 35

- Selecting the Active Port, 36

- Summary Table, 39

- Hotkey Mode

- auto scanning, 36
- exiting, 35
- invoking, 35

I

- Installation

- Single Station, 12

- Invoking Hotkey Mode, 35

K

- Keyboard Emulation

- Mac, 41

- Sun, 42

- KH1508

Front View, 6

Rear View, 8

KH1516

Front View, 6

Rear View, 8

KVM adapter installation, 14

L

LEDs

Port, 7

Station ID, 7

LIST, 25

Logout, 34

Logout Timeout, 28

LOUT, 34

O

OSD

Factory Default Settings, 54

Functions, 24

Hotkey, 21, 26

Logout, 34

Main Screen, 21, 22

Main Screen Headings, 23

Navigation, 23

Overview, 21

Password, 21

P

Password, 21, 28

Pause, 33

Port

LEDs, 7

Names, 29

Selection, 17

Port ID

Display Duration, 26

Display Mode, 27

Display Position, 26

Numbering, 19

Powering Off and Restarting, 19

Q

Quick View Ports, 30

R

Rack Mounting, 11

Rear View, 8

Requirements

Computer, 4

Console, 4

KVM Adapter Cables, 4

Operating Systems, 5

Reset Station IDs, 31

Reset Switch, 7

Restore Default Values, 29

S

Safety Instructions

General, iv

Rack Mounting, vi

SCAN, 33

Scan Duration, 27

SCAN/SKIPMODE, 27

Screen Blanker, 27

Selecting the Active Port, 36

SET, 26

Accessible Ports, 30

Logout Timeout, 28

Password, 28

Quick View Ports, 30

USERNAME, 28

Setting the Auto Scan Interval, 36

Single Station Installation, 12

Skip Mode, 27, 32, 38

SKP, 32

Stacking, 10

Station ID LEDs, 7

Station IDs

Reset, 31

T

Timeout, 28

Troubleshooting, 57

U

Upgrading the firmware, 43

User Notice, iii

Username, 28